

FLOOR SOUND INSULATION

STANDARD 2

from typical technical solutions album of Technosonus and NIISF
version TS/01.2020/RD/S/R4 type S-4.1

components:

StopZvuk M / Zvukolzol Hydro
Vibroflor sheet
Reinforced tape

The system reduces transmission of impact noise to lower premises to standard values specified by SNIIP 23-03-2003 and provides a reliable waterproofing layer in accordance with GOST 2678-93 requirements.

 SYSTEM
THICKNESS
59 mm

 AIRBORNE
NOISE REDUCTION
Rw = 59 dB

 SOUND INSULATION
ADDITION
▲ Rw = 8 dB

 IMPACT NOISE
REDUCTION
▲ Lnw = 35 dB



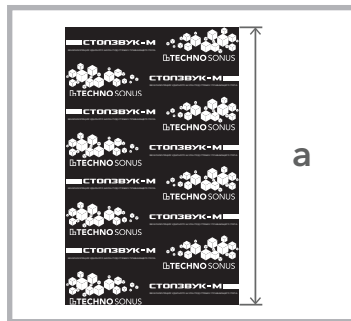
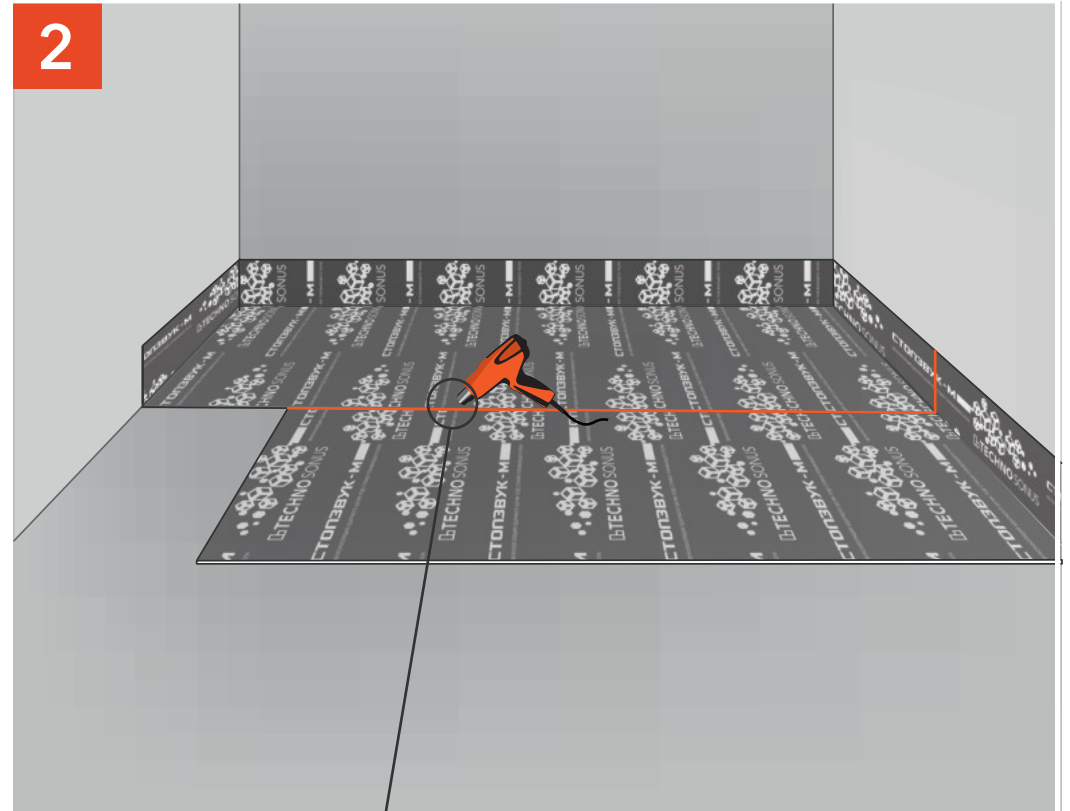
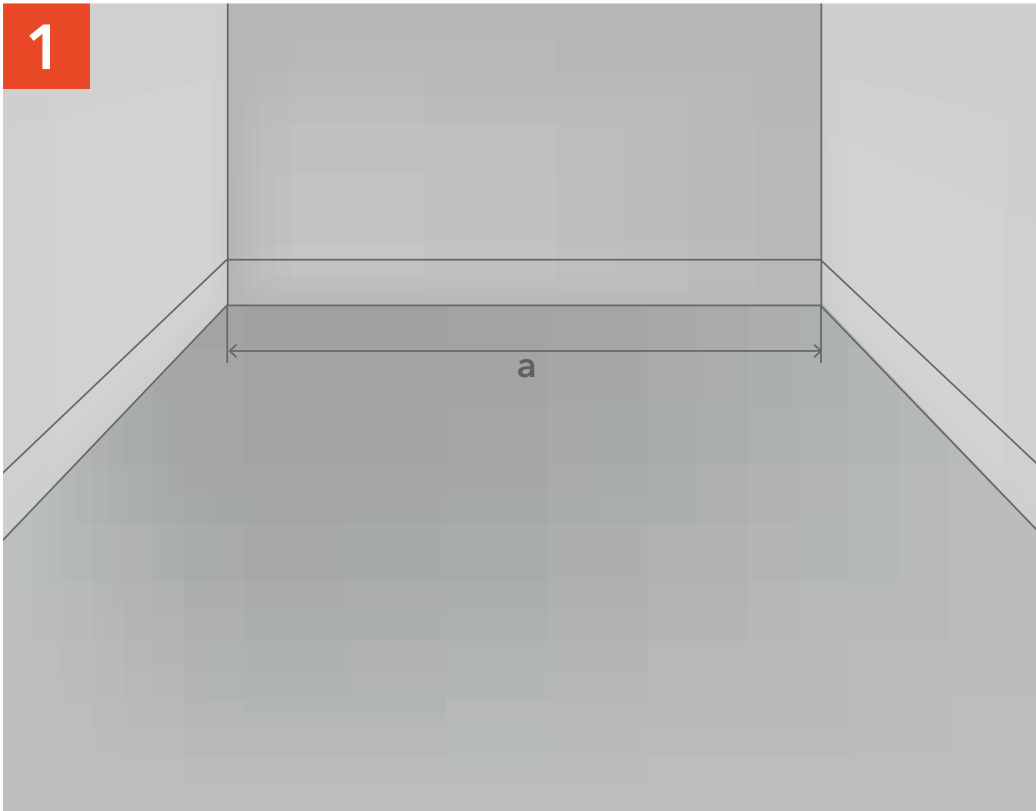

Measure premise width.

Lay StopZvuk M with wall overlapping to finish floor level.
Connect the seams thermally (using a hot gun or special soldering copper).

STANDARD 2 FLOOR SOUND INSULATION

STANDARD 2 FLOOR SOUND INSULATION

3

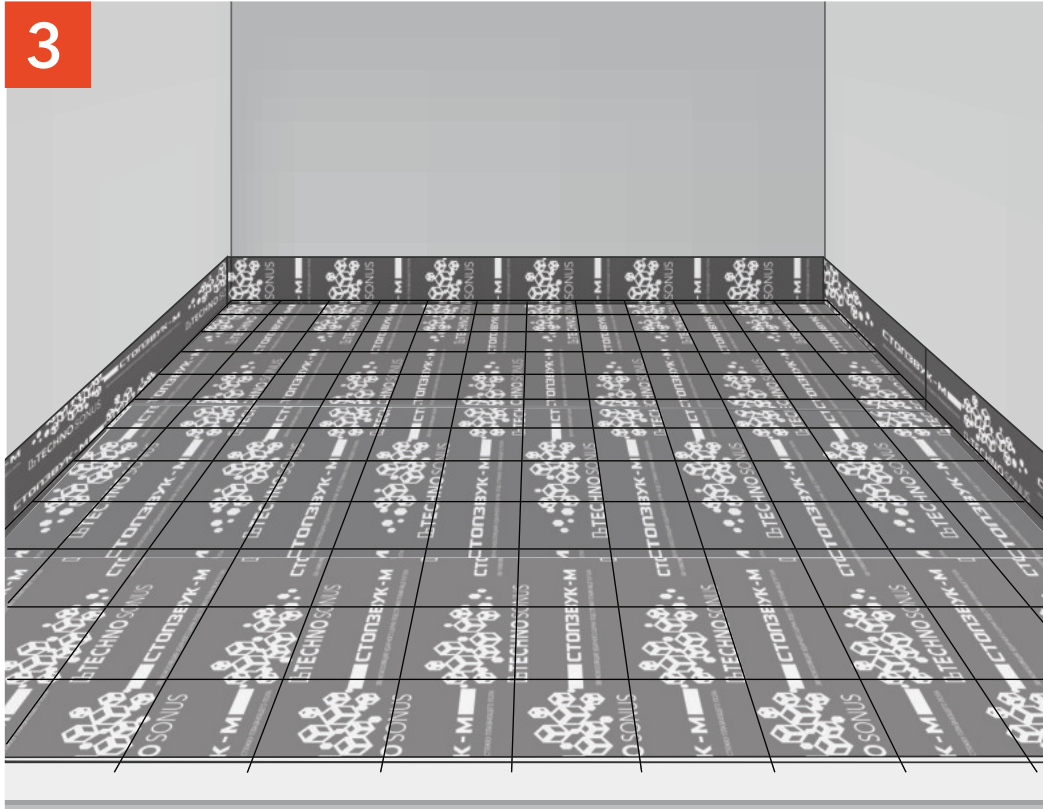

4

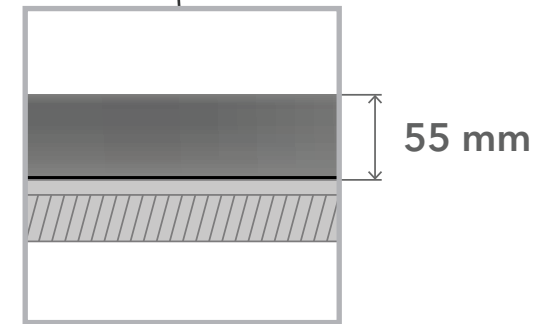
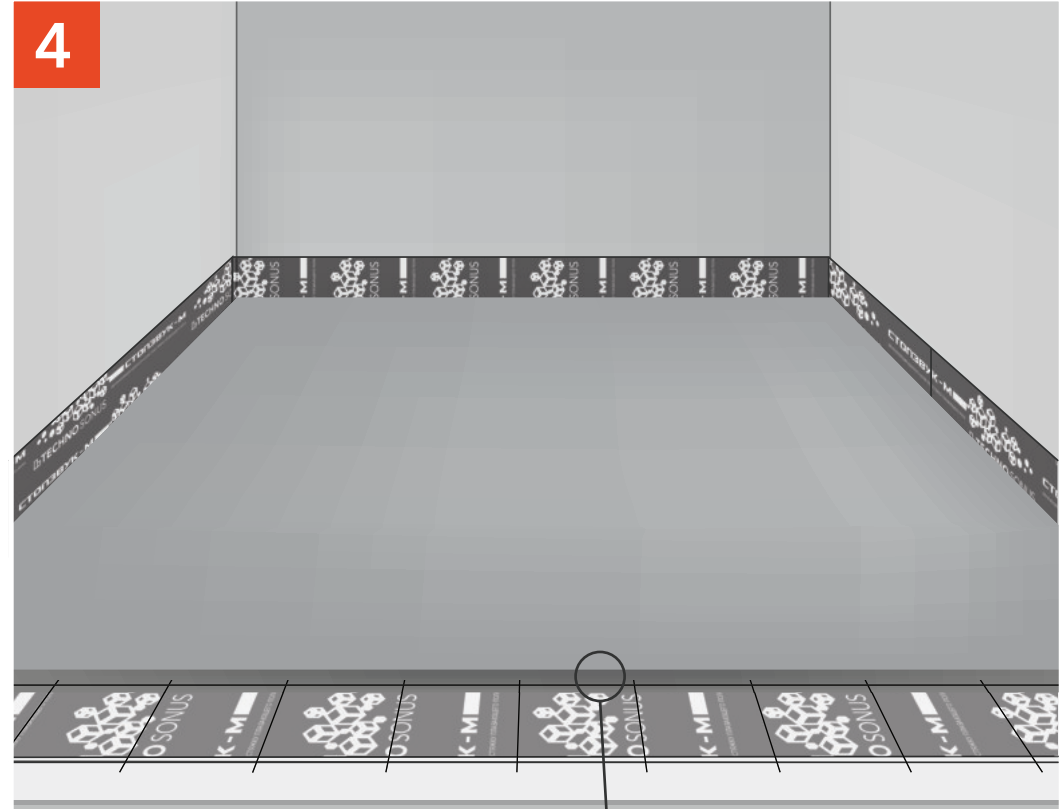

Lay a steel mesh for screed reinforcement.
When using a semi-dry screed, steel mesh reinforcement is not required.

Pour the screed 50 mm thick minimum.

5

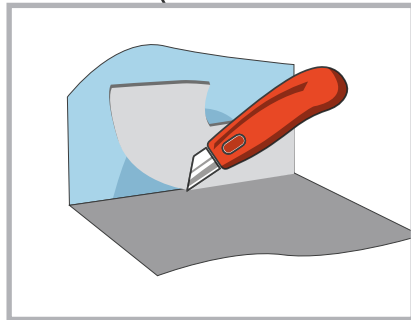
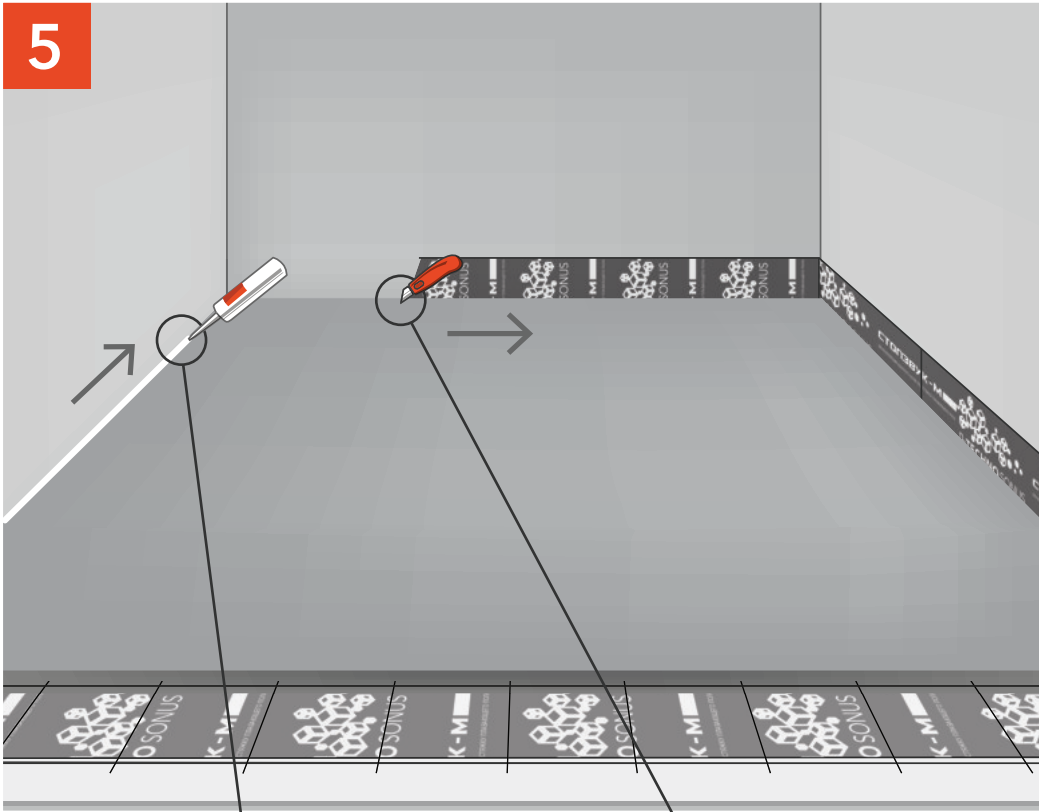

Cut off ThermoZvukolzol surplus and fill the space with Sonetik vibroacoustic sealant.

6

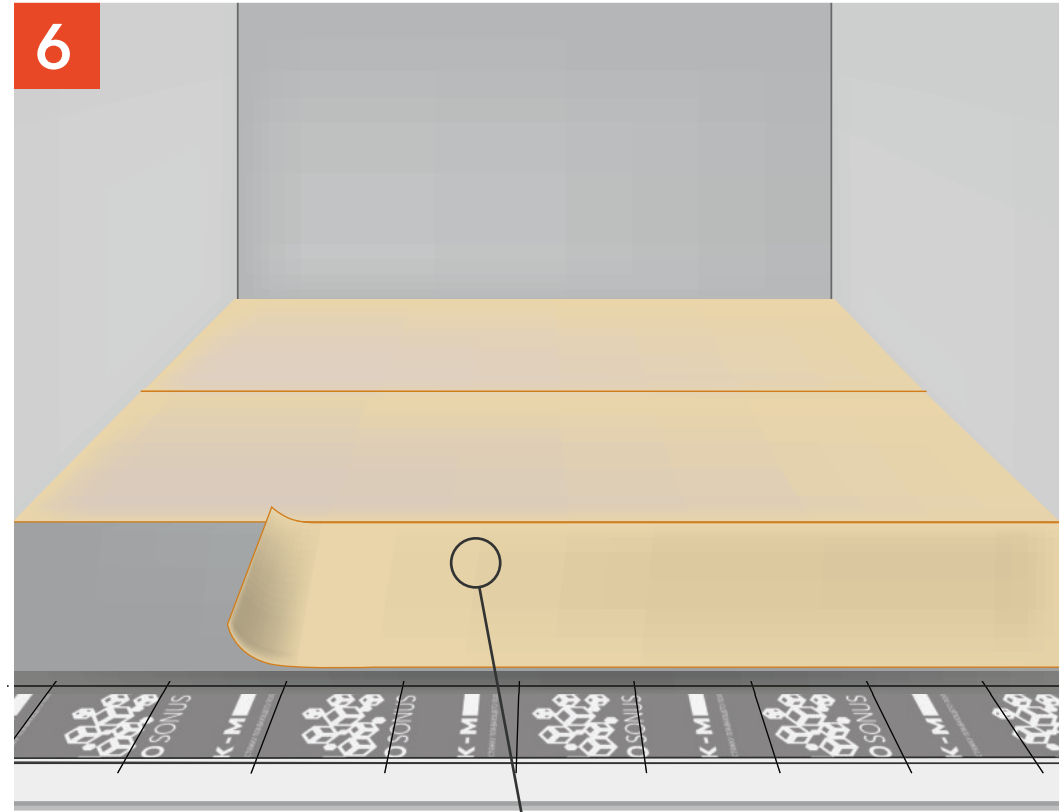

Spread Vibroflor.

STANDARD 2 FLOOR SOUND INSULATION

STANDARD 2 FLOOR SOUND INSULATION

7



Lay finish coating.
